

Measuring Guide for Wood Blinds and Faux Wood Blinds

Tools and Tips

- Steel tape measure – do not use cloth tape
- Pencil
- Measurement Worksheet – attached
- Measure each window and identify window locations – size variances are common
- Round measurements to the nearest 1/8"
- Clearly record measurements – width vs. height

Double-check your work—always measure twice to ensure accuracy.

7/8" →
3/4" →
5/8" →
1/2" →
3/8" →
1/4" →
1/8" →

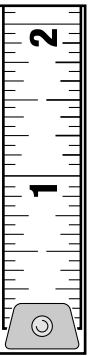

Choose a Mount Type: Inside Mount or Outside Mount

(See next page if you need help deciding which mount is best for your windows.)

Inside Mount

Window treatments are installed inside the window casing.

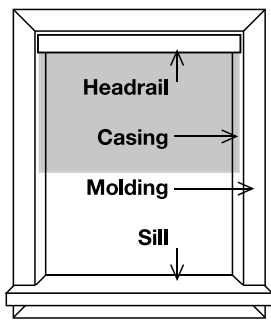

Inside Mount Blind

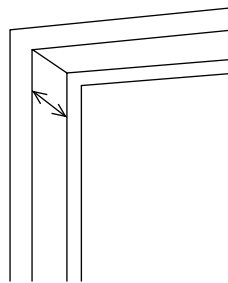

Depth

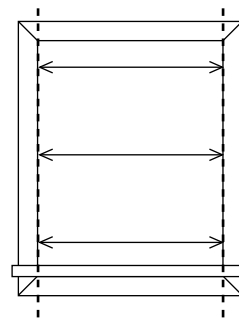

Width

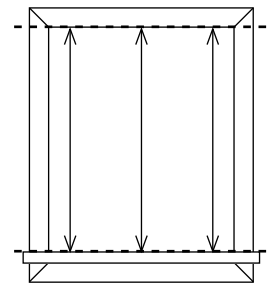

Height

- 1 **Measure Depth:** Measure your depth to see if you have full recess depth. If you do, no returns are necessary. If you do not, please see the special return section of this measuring guide. 3/4" is the minimum depth required for inside mount blinds.
- 2 **Measure Width:** Measure the inside width of window casing in three places. Record narrowest measurement.
- 3 **Measure Height:** Measure the inside height from the top of window casing to top of sill in three places. Record longest measurement.

Note: Do not take any deductions for clearance. The manufacturer will take necessary deductions for a perfect fit.

Outside Mount

Window treatments are installed outside the window casing. Mount directly to wall or molding.

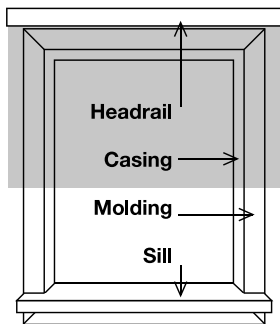

Outside Mount Blind

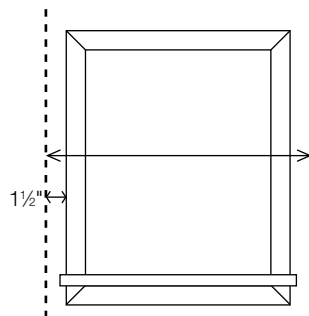

Width

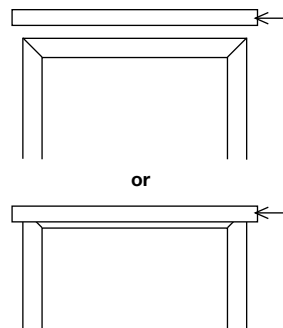

Headrail Location

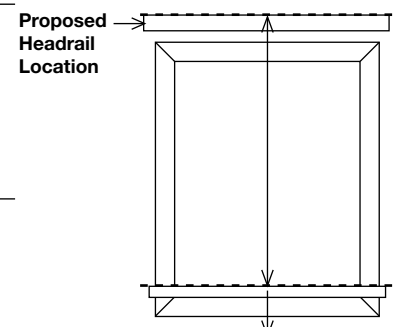

Height

- 1 **Measure Width:** Measure width to be covered. We recommend 1 1/2" overlap on each side of the window (3" total) for optimum light control and privacy. Record measurement.
- 2 **Determine Headrail Location** Determine if headrail will be on molding or above molding and mark spot.
- 3 **Measure Height:** Measure height to be covered from top of headrail location to top of sill or lower if overlap is desired for additional light control and privacy. Record measurement.

Note: The manufacturer makes NO deductions on outside-mount installations.

Mounting Considerations

Reason for Choosing Inside Mount

- Inside mount treatments are installed inside the window casing, showcasing attractive window trim.
- In some deep-set windows, the window treatment can be installed to allow plants or other items to be placed in front of the window treatment on the sill.

Limitations of Inside Mount

- A small deduction in the width and/or length is taken by the manufacturer to allow for proper operating clearance, and this causes small amount of light to spill through on each side of the treatment.
- The stack (thickness of the window treatment when fully raised) will obstruct part of the view from the window.
- Obstacles such as handles and cranks can interfere with the operation of inside mount treatments.

Reason for Choosing Outside Mount

- Light spilling through on the side of the window treatment can be substantially diminished or eliminated.
- Outside mount window treatments are ideal for covering windows that are not level.
- Outside mount window treatments are installed higher than the window opening for an unobstructed view when fully raised.
- Outside mount window treatments can clear obstacles like handles and cranks.
- Increase overlap above and below or to each side of the window to enlarge the look of a small window.
- Outside mount treatments can easily hide unattractive window trim.



Limitations of Outside Mount

- Brackets require at least 2" of flat surface above window or on window frame for installation; Projection brackets or shims can be ordered if needed to clear frame or molding.

Special Return Ordering

- Find your valance profile on the options chart, and then find the **standard return length** for your product and tilt or control type.
- Subtract your **depth** from your **standard return length**. This calculation is your **special return length**.
- Place order **with special return length**.

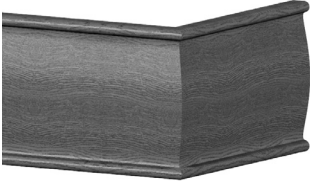
Valance Options

| Valance Type | Blind Type | Standard | Optional | Maximum Continuous Width* | | Tilt Type | Standard Return Length | Full Recess Depth |
|--|--|----------|----------|---------------------------|---------------|-----------|------------------------|-------------------|
| | | | | Inside Mount** | Outside Mount | | | |
| 2½" Standard Valance  Valance Returns ½" to 1": glued 1⅛" to 4⅝": optional glued 4⅞" and greater: not glued Keystone not available | 2" Northern Heights™ Bamboo | N/C | | 94¼" | 93⅞" | Wand | 3⅞" | 3⅞" |
| | 2" Composite | N/C | | 106⅝" | 105⅝" | Cord | 2⅞" | 3¼" |
| | | | | | | Cordless | 3⅞" | 3¾" |
| | | N/C | | | | Wand | 3⅞" | 3⅞" |
| | 2½" Double Bevel Composite | N/C | | 106⅝" | 105⅝" | Cord | 3⅞" | 4¼" |
| | | | | | | Cordless | 3⅞" | 3¾" |
| | 2" Premium Faux Wood 2" Faux Wood | N/C | | 106⅝" | 105⅝" | Wand | 3⅞" | 3⅞" |
| | | | | | | Cord | 2⅞" | 3¼" |
| | 2½" Premium Faux Wood 2½" Faux Wood | N/C | | 106⅝" | 105⅝" | Cordless | 3⅞" | 3¾" |
| | | | | | | Cord | 3⅞" | 4¼" |
| 3" Standard Valance  Valance Returns ½" to 1": glued 1⅛" to 4⅝": optional glued 4⅞" and greater: not glued | 1" Northern Heights | N/C | | 100¼" | 98⅝" | Wand | 2⅞" | 2⅞" |
| | 2" Northern Heights | N/C | | 100¼" | 98⅝" | Wand | 3⅞" | 3⅞" |
| | | | | | | Cord | 2⅞" | 3¼" |
| | Northern Heights Vertical | N/C | | 100¼" | 98⅝" | N/A | 5½" | 5⅞" |
| | | | | | | Cordless | 3⅞" | 3¾" |
| | 2" Bali® Essentials | N/C | | 78" | 76" | Cord | 2⅞" | 3¼" |
| 2½" Northern Heights Shutter Style | N/C | | 100¼" | 97¾" | Cord | 3⅞" | 4¼" | |
| | | | | | Cordless | 3¾" | 4⅞" | |



*Continuous valances wider than sizes shown above will have two or more sections spliced together with a keystone. Maximum width for spliced valance is 300".

**Assumes no returns on inside mount.

N/C – No charge when ordered with the blind

\$ – Surcharge; see Price Charts

Valance Options

| Valance Type | Blind Type | Standard | Optional | Maximum Continuous Width* | | Tilt Type | Standard Return Length | Full Recess Depth | | |
|--|--------------------------------------|----------|----------|---------------------------|---------------|-----------|------------------------|-------------------|-----|-----|
| | | | | Inside Mount** | Outside Mount | | | | | |
| 3½" Premium Traditional Valance  Valance Returns ½" to 1": glued 1⅛" to 4⅝": optional glued 4⅞" and greater: not glued | 1" Northern Heights | | \$ | 100¼" | 98⅝" | Wand | 2⅛" | 2⅞" | | |
| | 2" Northern Heights | | \$ | 100¼" | 98⅝" | Wand | 3⅞" | 4⅞" | | |
| | | | | | | Cord | 2⅞" | 3½" | | |
| | | N/C | | | | Cordless | 3⅞" | 4" | | |
| | 2" Northern Heights Distressed^ | N/C | | | 100¼" | 98⅝" | Wand | 3⅞" | 4⅞" | |
| | | | | | | | | Cord | 2⅞" | 3½" |
| | | | | | | | | Cordless | 3⅞" | 4" |
| 2½" Northern Heights Shutter Style | N/C | | | 100¼" | 98⅝" | Cord | 3⅞" | 4⅞" | | |
| | | | | | | | Cordless | 3¾" | 4⅞" | |
| Northern Heights Vertical | N/C | | | 100¼" | 98⅝" | N/A | 5½" | 6⅞" | | |
| 4½" Eloquence Valance  Valance Returns ½" to 1": glued 1⅛" to 4⅝": optional glued 4⅞" and greater: not glued | 1" Northern Heights™ | | \$ | 100¼" | 98⅝" | Wand | 2⅛" | 2⅞" | | |
| | 2" Northern Heights | | \$ | 100¼" | 98⅝" | Wand | 3⅞" | 4⅞" | | |
| | | | | | | Cord | 2⅞" | 3⅞" | | |
| | | | | | | Cordless | 3⅞" | 4⅞" | | |
| | 2½" Northern Heights Shutter Style | | | \$ | 100¼" | 98⅝" | Cord | 3⅞" | 4⅞" | |
| | | | | | | | Cordless | 3¾" | 4½" | |
| Northern Heights Vertical | | | \$ | 100¼" | 98⅝" | N/A | 5½" | 6¼" | | |
| 3¼" Eloquence Valance  Valance Returns ½" to 1": glued 1⅛" to 4⅝": optional glued 4⅞" and greater: not glued Keystone not available | 2" Composite | | N/C | 106⅝" | 105⅝" | Wand | 3⅞" | 4" | | |
| | | | | | | Cord | 2⅞" | 3⅞" | | |
| | | N/C | | | | Cordless | 3⅞" | 3⅞" | | |
| | 2½" Double Bevel Composite | | N/C | 106⅝" | 105⅝" | Cord | 3⅞" | 4⅞" | | |
| | 2" Premium Faux Wood 2" Faux Wood | | \$ | 106⅝" | 105⅝" | Wand | 3⅞" | 4" | | |
| | | | | | | Cord | 2⅞" | 3⅞" | | |
| 2½" Premium Faux Wood 2½" Faux Wood | N/C | | 106⅝" | 105⅝" | Cordless | 3⅞" | 3⅞" | | | |
| | | \$ | | | Cord | 3⅞" | 4⅞" | | | |
| | N/C | | | 106⅝" | 105⅝" | Cordless | 3¾" | 4⅞" | | |

*Continuous valances wider than sizes shown above will have two or more sections spliced together with a keystone.

Maximum width for spliced valance is 300".

**Assumes no returns on inside mount.

\$ – Surcharge; see Price Charts.

N/C – No charge when ordered with the blind.

^Keystone not available.

Measuring and Ordering Worksheet

Window #1 _____

(location)

Measuring

For Inside Mount

Depth of window casing: _____

Special Return Length

(Standard Return Length XX - Depth XX = Special Return Length XX)

Standard Return Length: _____

Depth: _____

Special Return Length: _____

Measure width of window in 3 places and circle the narrowest width below:

Width #1: _____

Width #2: _____

Width #3: _____

Measure height of window in 3 places and circle the longest height below:

Height #1: _____

Height #2: _____

Height #3: _____

For Outside Mount

Width: _____

Height: _____

Ordering

Mount Type: Inside Outside

Ordering Width: _____

Ordering Height: _____

Type of Blind or Shade: _____

Style Name: _____

Color Number: _____

Controls & Options to consider:

Corded

Cordless

Bottom Up/Top Down
(Cellular, Pleated, Roman, and Natural Shades)

Sun Up/Sun Down
(Cellular & Pleated Shades only)

Cornice: _____

Valance: _____

Other: _____

Window #2 _____

(location)

Measuring

For Inside Mount

Depth of window casing: _____

Special Return Length

(Standard Return Length XX - Depth XX = Special Return Length XX)

Standard Return Length: _____

Depth: _____

Special Return Length: _____

Measure width of window in 3 places and circle the narrowest width below:

Width #1: _____

Width #2: _____

Width #3: _____

Measure height of window in 3 places and circle the longest height below:

Height #1: _____

Height #2: _____

Height #3: _____

For Outside Mount

Width: _____

Height: _____

Ordering

Mount Type: Inside Outside

Ordering Width: _____

Ordering Height: _____

Type of Blind or Shade: _____

Style Name: _____

Color Number: _____

Controls & Options to consider:

Corded

Cordless

Bottom Up/Top Down
(Cellular, Pleated, Roman, and Natural Shades)

Sun Up/Sun Down
(Cellular & Pleated Shades only)

Cornice: _____

Valance: _____

Other: _____

Window #3 _____

(location)

Measuring

For Inside Mount

Depth of window casing: _____

Special Return Length

(Standard Return Length XX - Depth XX = Special Return Length XX)

Standard Return Length: _____

Depth: _____

Special Return Length: _____

Measure width of window in 3 places and circle the narrowest width below:

Width #1: _____

Width #2: _____

Width #3: _____

Measure height of window in 3 places and circle the longest height below:

Height #1: _____

Height #2: _____

Height #3: _____

For Outside Mount

Width: _____

Height: _____

Ordering

Mount Type: Inside Outside

Ordering Width: _____

Ordering Height: _____

Type of Blind or Shade: _____

Style Name: _____

Color Number: _____

Controls & Options to consider:

Corded

Cordless

Bottom Up/Top Down
(Cellular, Pleated, Roman, and Natural Shades)

Sun Up/Sun Down
(Cellular & Pleated Shades only)

Cornice: _____

Valance: _____

Other: _____